

# DRIE FACETTEN VAN BEVOCHTING

## HOE HYGIËNE, COMFORT EN ENERGIEBESPARING TE COMBINEREN?

09/06/2021

*Olivier de Caritat*

*Technical Director Microniser*

*Patrick de Visscher*

*Energy & Innovation Manager VINCI Facilities*

*Karla Dinne*

*Labo hoofd Microbiologie en Gezondheid at WTCB-CSTC-BBRI*



BEVOCHTIGING DOOR VERSTUIVEN

microniser

[info@microniser.com](mailto:info@microniser.com)

[www.microniser.com](http://www.microniser.com)

Atic  
for HVAC professionals



microniser  
humidification

# CONTEXT: BEVOCHTIGING

Waarom bevochtigen?

- ▲ Luchtkwaliteit
- ▲ Vermindering van luchtwegen aandoeningen
- ▲ Comfort in het gebouw

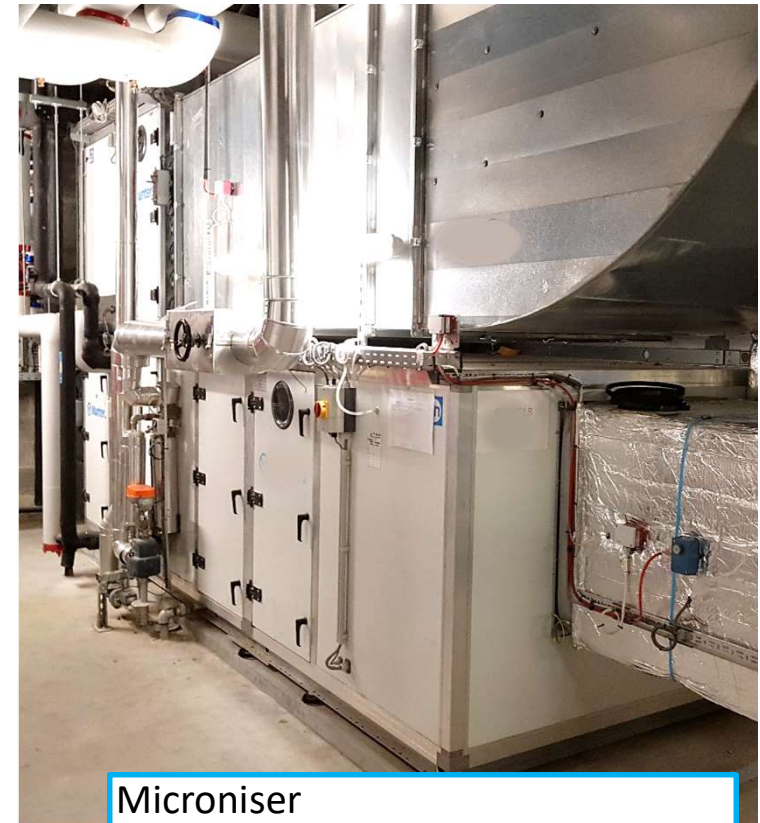
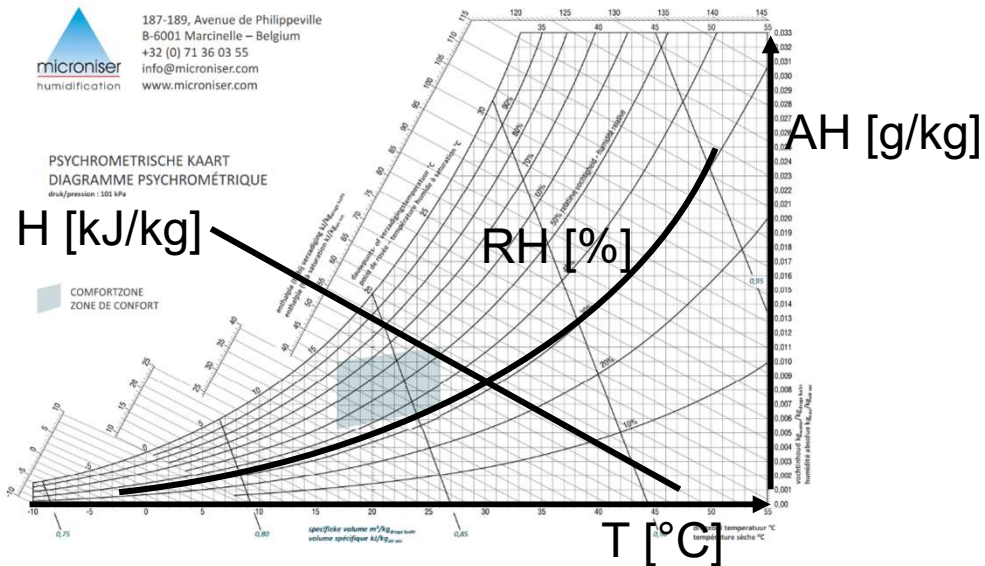

Microniser  
▲ Voor LBK >10.000m<sup>3</sup>/h  
▲ Voor gebouw > 2000m<sup>2</sup>

## WERKING

---

Water dringt door de zeefkooi  
en wordt in fijne druppeltjes afgebroken : 20  $\mu\text{m}$

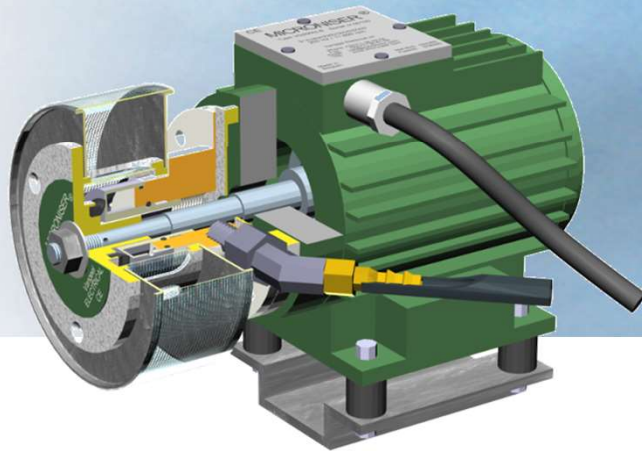

Atic

for HVAC professionals

Economisch - Ecologisch - Hygiënisch

The logo for microniser humidification, featuring a blue triangle composed of small dots, with the text "microniser humidification" below it.

# FIJNE DRUPPELTJES VERDAMPEN GEMAKKELIJK

---

- ▲ GEEN WATERVERSPILLING
- ▲ MODULAIRE WATERSTROOM

Demonstratie-lab in onze Marcinelle-workshops  
Voor een bezoek: [info@microniser.com](mailto:info@microniser.com)

# BEVOCHTIGING IN LUCHTBEHANDELINGSEENHEID

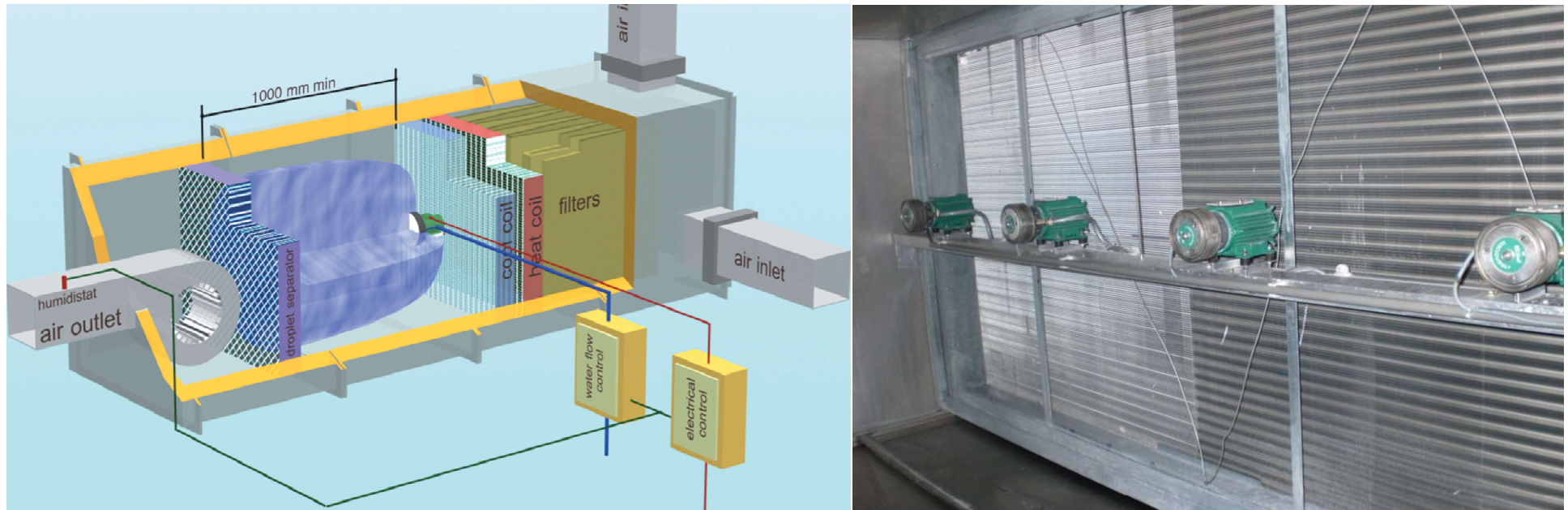

- ▲ ZEER LAAG ELEKTRISCH VERBRUIK
- ▲ BETROUWBAARHEID - EENVOUDIGHEID
- ▲ GEEN AFVALWATER
- ▲ GEEN BACTERIËLE ONTWIKKELING
- ▲ MODULAIRE STROOM

## BEVOCHTIGING IN HVAC-GROEP

---

- ▲ ZEER LAGE CONSUMPTIE
- ▲ BETROUWBAARHEID - EENVOUDIGHEID
- ▲ GEEN AFVALWATER
- ▲ GEEN BACTERIËLE ONTWIKKELING
- ▲ MODULAIRE STROOM
- ▲ COMMUNICATIE MET GTB

Atic

for HVAC professionals



Economisch - Ecologisch - Hygiënisch

microniser  
humidification

# TOEPASSINGSGEBIEDEN

---

- BEVOCHTIGING
- ADIABATISCHE KOELING
- STOFBESTRIJDING
- GEURVRIJ VERWERKING



Atic  
for HVAC professionals

microniser  
humidification

Economisch - Ecologisch - Hygiënisch



# ADIABATISCHE KOELING NAUWKEURIG EN ZEER ECONOMISCH



# REGULATIE



- Vrijgave & Instelpunt GTB/BMS
- Metingen
- Gebreken
- Real Time Status

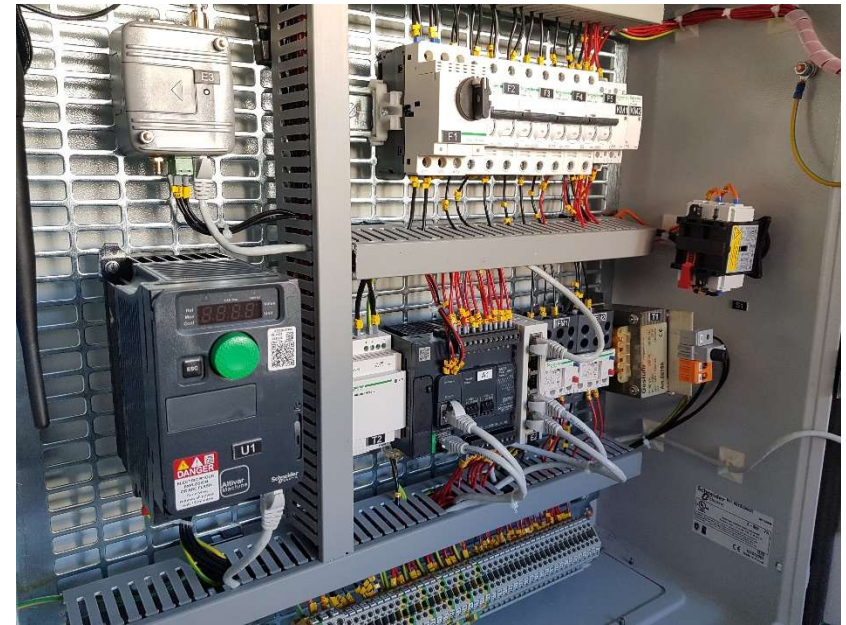
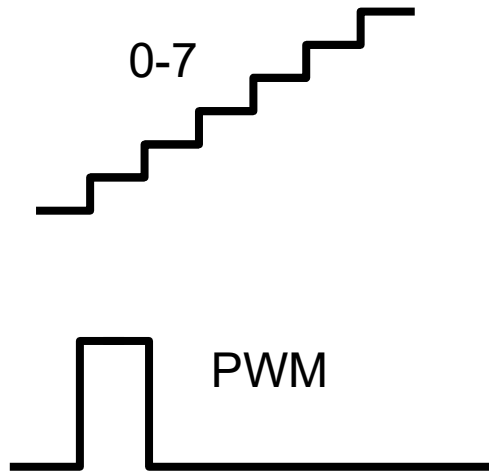

GTB Instelpunt  
%RV meting  
% waterdebiet

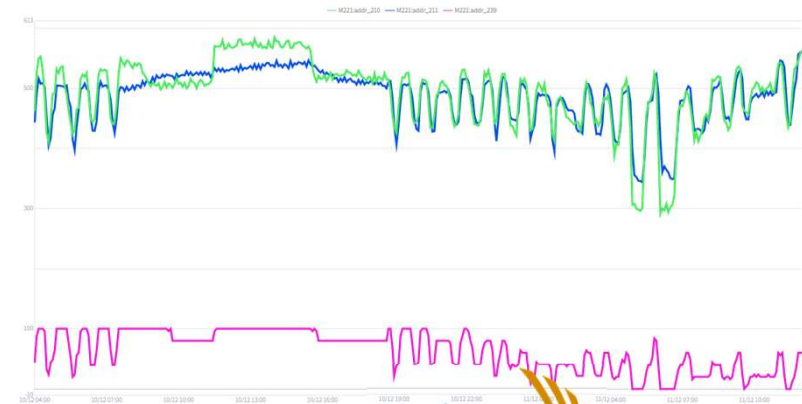

Atic  
for HVAC professionals



Economisch - Ecologisch - Hygiënisch

# REGULATIE

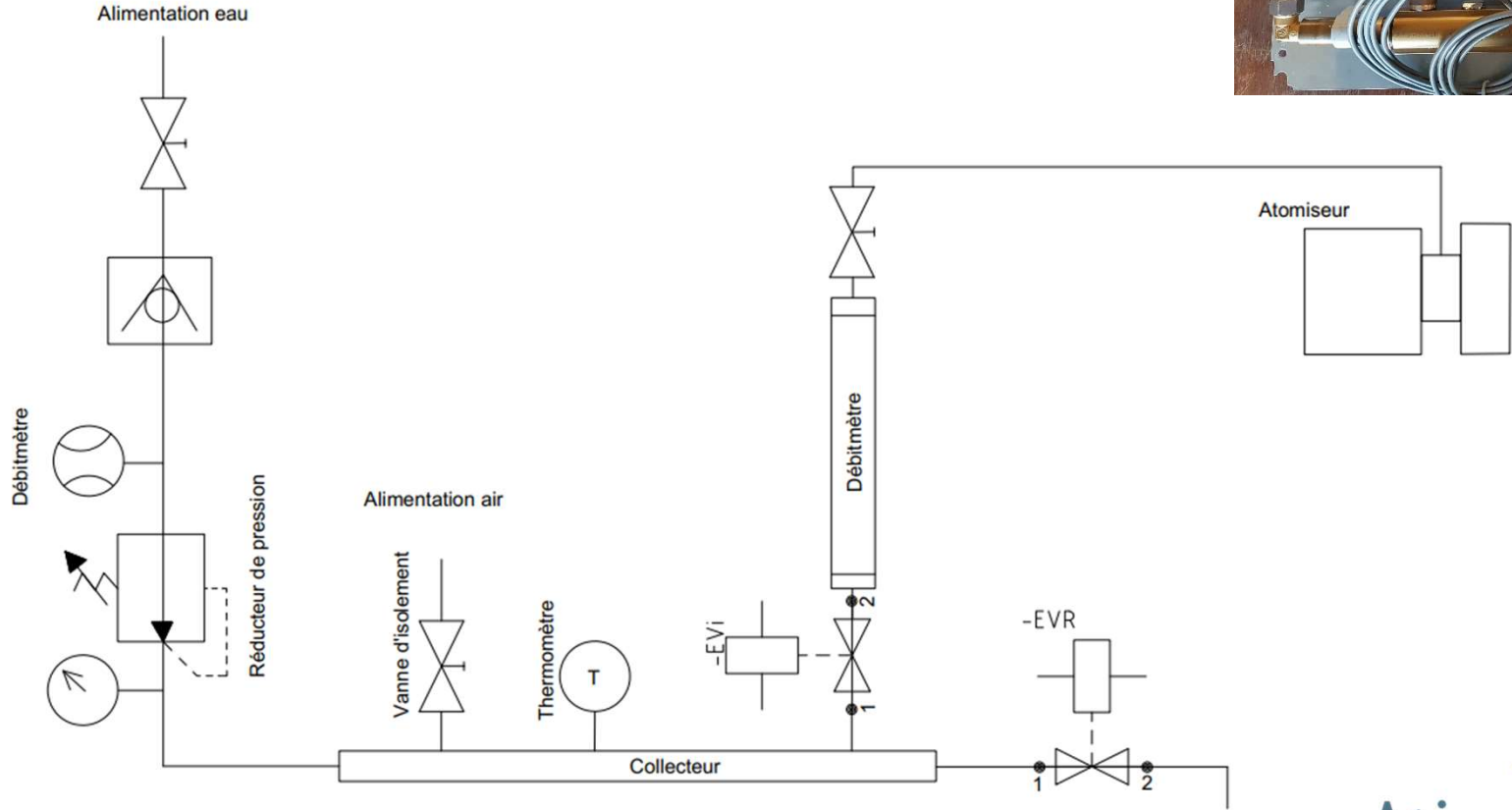
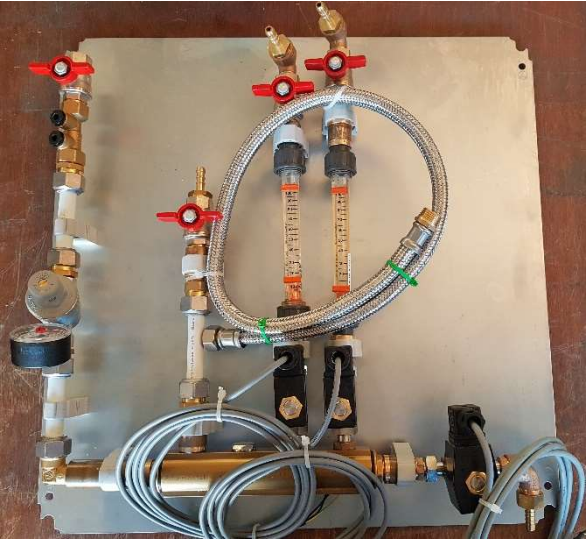

# HYGIËNE - RISICO'S TE VERMIJDEN

---



Luchtbevochtiger met recirculatie ondanks reiniging om de twee weken ...



Stilstaand water in LBK dat al jaren stilstaat ...

# HYGIËNE - WATERKWALITEIT

---



Microniser na 42.000 bedrijfsuren met RO water



Microniser na 3500 bedrijfsuren met onthard water (10°f)

# HYGIËNE - WATERKWALITEIT

Temperatuur en stagnatietijd beïnvloeden de ontwikkeling van legionella:

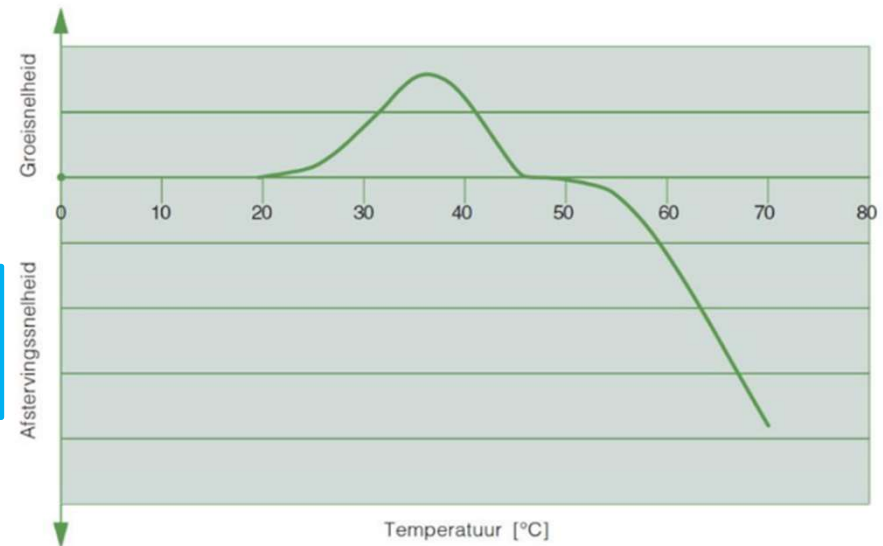

référence: Brundrett, 1992, Legionella and Building Services

Gezonde en gecontroleerde bevochtiging met Microniser:

- ▲ Houd koud water <math><20^{\circ}\text{C}</math>
- ▲ Stagnatie voorkomen
- ▲ Purge & Rinsing Programmeerbaar
- ▲ Behoud een laag risiconiveau: <math><1000\text{ CFU/L}</math>
- ▲ Aanvullende behandelingen aanbevolen per geval: filtratie, omgekeerde osmose, chemische behandeling, thermische behandeling, UV

# KOOP OF FULL SERVICE MICRONISER IS GOEDKOPER DOOR LAGE OPERATIONELE KOSTEN

Coûts d'investissement et d'exploitation cumulés

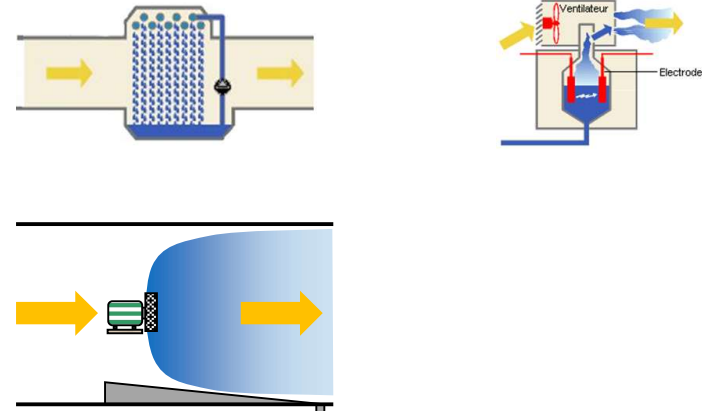
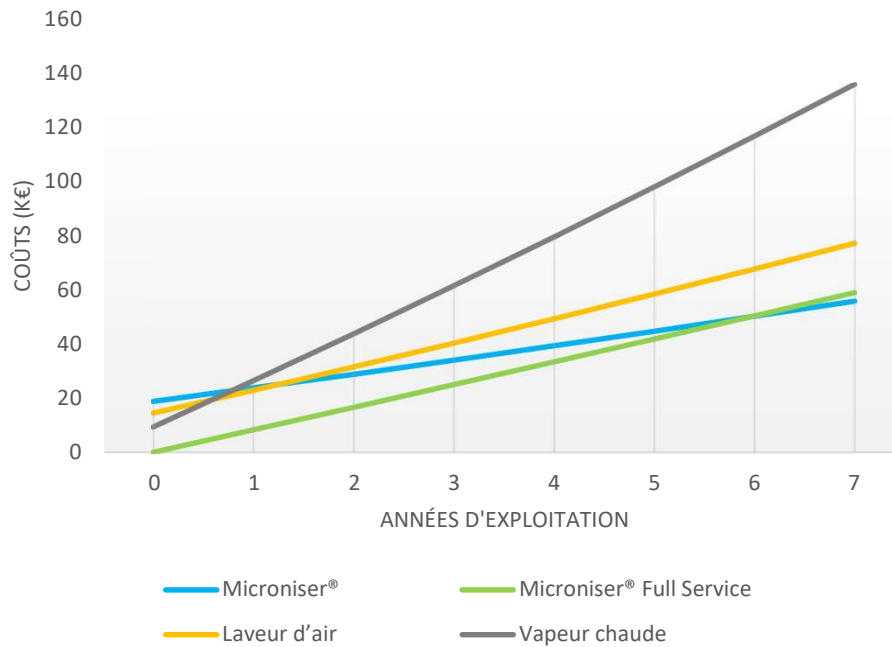

## KOOP

- ROI < 1 jaar

## FULL SERVICE

- 0 € investering
- Onmiddellijke besparingen

## MICRONISER FULL SERVICE

---

- Equipment Supply
- Installation & Start-up
- Maintenance & Warranty
- Performance Monitoring



Zero Investment



Low Rent and Operating Cost



Included Monitoring and Maintenance



Real-Time Diagnostic



Immediate Water and Energy Savings



# MORE THAN 1000 SUCCESS STORIES

---



Parlamentum Europaeum



DERICHEBOURG



Economisch - Ecologisch - Hygiënisch The logo for microniser humidification, featuring a blue pyramid shape made of dots, with the text 'microniser humidification' below it.



# microniser

nieuw project uitrusten?  
systeem milieuvriendelijker maken?

OLIVIER DE CARITAT  
+32 (0) 71 36 03 55  
info@microniser.com  
www.microniser.com

Atic  
for HVAC professionals



microniser  
humidification